

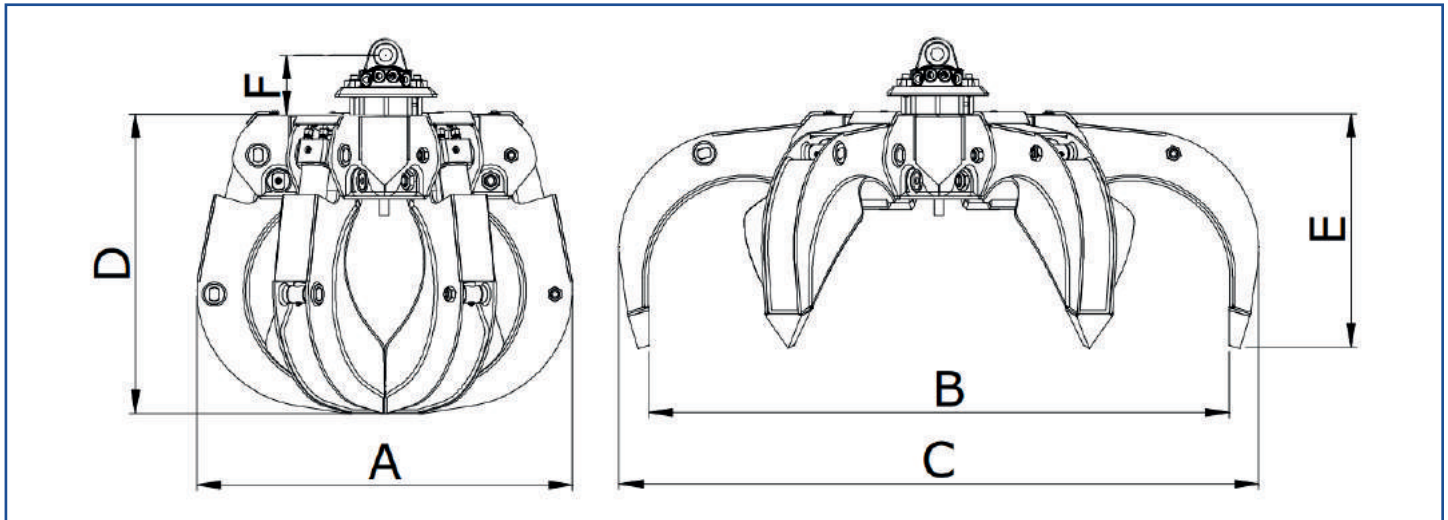





Attrezzature per macchine operatrici – Equipments for operating machines.
POLIPY ORIZZONTALI LEGGERI PER RIFIUTI URBANI ED IMPIEGHI GENERICI
POLYP-GRAB FOR GENERAL USE AND LIGHT MATERIALS' HANDLING



Modello - Model		ROL 14	ROL 18	ROL 25	ROL 30	ROL 35	ROL 40
Classe - Class		M01	M10	M02	M20	M20 - M03	M03
Peso - Weight	kg	275	335	395	425	455	495
Denti - Teeth	n°	4	5	5	5	5	6
Capacità - Capacity	lt	140	180	250	300	350	400
Capacità di carico - Load capacity	ton	3	4	4	4	4	5
Pressione - Pressure (Max)	bar	300	300	300	300	300	300
Peso macchina - Machine weight	ton	5/8	6/10	8/12	8/12	10/15	12/15
A	mm	920	970	1010	1050	1120	1080
B	mm	1260	1400	1560	1680	1740	1890
C	mm	1420	1570	1720	1840	1920	2040
D	mm	680	760	840	910	940	1010
E	mm	620	640	670	690	700	720
F	mm	110	110	130	130	130	130

-  INCLUDED: POLYP, ROTATION (RDT), LINK
-  INCLUSO: POLIPO, ROTAZIONE (RDT), LINK
-  INCLUS : POLYPE, ROTATION (RDT), LIEN
-  INCLUYE: PÓLIPO, ROTACIÓN (RDT), LINK
-  INKLUSIVE: POLYPEN, ROTATION (RDT), LINK
-  ВКЛЮЧЕНО: ПОЛИП, ВРАЩЕНИЕ (RDT), ССЫЛКА

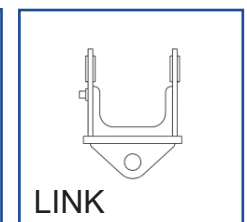
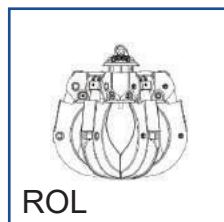

N.B. Questi dati e descrizioni s'intendono forniti a solo titolo indicativo, e non sono impegnativi per la Casa Costruttrice la quale si riserva il diritto di apportare variazioni e modifiche che si rendessero necessarie per ottenere ulteriori miglioramenti qualitativi delle attrezzature.
NOTE These data and descriptions are to be considered only as indicative information and they are not binding for the Building Firm which has the power to make variations and change whatever necessary to obtain further improvements of quality in the equipments.